

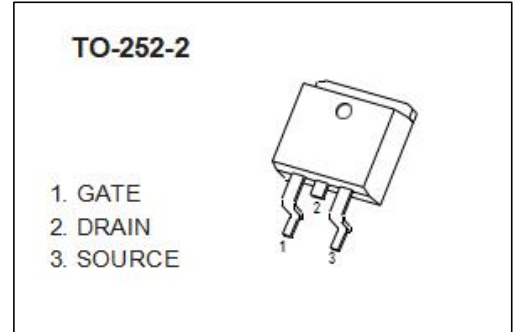

TO-252 Plastic-Encapsulate MOSFETS

CCMC100N10S N-Channel Power MOSFET

$V_{(BR)DSS}$	$R_{DS(on)TYP}$	I_D
100V	5.0 mΩ@10V	100A



DESCRIPTION

The CCMC100N10S uses advanced SGT technology and design to provide excellent $R_{DS(ON)}$ with low gate charge. It can be used in a wide variety of applications.

FEATURE

- Extremely low on-resistance $R_{DS(on)}$
- Excellent $Q_g \times R_{DS(on)}$ product(FOM)
- Qualified according to JEDEC criteria
- AEC Q101 Qualified

APPLICATION

- Motor control and drive
- Battery management
- UPS(Uninterruptible Power Supplies)

MARKING

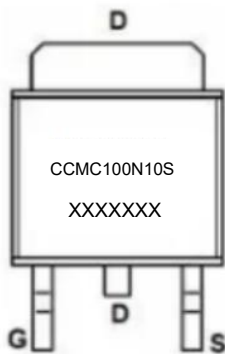

CCMC100N10S =Part No.
XXXXXXX = Code

EQUIVALENT CIRCUIT

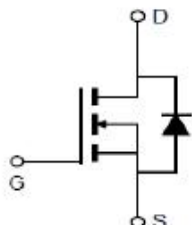

ABSOLUTE MAXIMUM RATINGS(TC=25°C unless otherwise noted)

Parameter	Symbol	Limit	Unit
Drain-Source Voltage	V _{DS}	100	V
Gate-Source Voltage	V _{GS}	±20	V
Continuous Drain Current	I _D	100	A
Pulsed Drain Current ¹	I _{DM}	400	A
Single Pulse Avalanche Energy ²	E _{AS}	61	mJ
Total Power Dissipation	P _D	180	W
Thermal Resistance from Junction to Case	R _{θJC}	0.83	°C/W
Operating Junction and Storage Temperature Range	T _J , T _{STG}	-55~+175	°C
Soldering Temperature , for 10S(1.6mm from case)	-	260	°C

Notes:

1.Repetitive Rating: Pulse width limited by maximum junction temperature.

2.EAS condition : T_j=25°C,L=0.1mH,R_g=25Ω,I_{as}=35A.

MOSFET ELECTRICAL CHARACTERISTICS

TC=25°C unless otherwise specified

Parameter	Symbol	Test Condition	Min	Type	Max	Unit
Off characteristics						
Drain-Source breakdown Voltage	$V_{(BR)DSS}$	$V_{GS} = 0\text{ V}, I_D = 250\ \mu\text{A}$		100		V
Zero gate voltage drain current	I_{DSS}	$V_{DS} = 100\text{ V}, V_{GS} = 0\text{ V}$			1	μA
Gate-body leakage current	I_{GSS}	$V_{DS} = 0\text{ V}, V_{GS} = \pm 20\text{ V}$		± 10	± 100	nA
On characteristics						
Gate threshold voltage ³	$V_{GS(th)}$	$V_{DS} = V_{GS}, I_D = 250\ \mu\text{A}$	2.0	3.0	4.0	V
Drain-source on-resistance ³	$R_{DS(on)}$	$V_{GS} = 10\text{ V}, I_D = 50\text{ A}$		5.0	6.0	m Ω
Transconductance	g_{fs}	$V_{DS}=10\text{ V}, I_D=10\text{ A}$		45		S
Dynamic characteristics¹						
Input Capacitance	C_{iss}	$V_{DS} = 25\text{ V}, V_{GS} = 0\text{ V}, f = 1\text{ MHz}$		6094		pF
Output Capacitance	C_{oss}			1560		
Reverse Transfer Capacitance	C_{rss}			205		
Gate resistance	R_g	$V_{GS} = 0\text{ V}, V_{DS}=0\text{ V}, f=1\text{ MHz}$		1.2		Ω
Switching characteristics¹						
Total Gate Charge	Q_g	$V_{DD} = 50\text{ V}, V_{GS} = 10\text{ V}, I_D = 50\text{ A}, f = 1\text{ MHz}$		112		nC
Gate-Source Charge	Q_{gs}			26		
Gate-Drain Charge	Q_{gd}			42		
Turn-on delay time	$t_{d(on)}$	$V_{DD} = 50\text{ V}, V_{GS} = 10\text{ V}, R_G = 2.7\ \Omega$		24		ns
Turn-on rise time	t_r			86		
Turn-off delay time	$t_{d(off)}$			54		
Turn-off fall time	t_f			92		
Drain-Source Diode Characteristics						
Drain-source diode forward Voltage ³	V_{SD}	$V_{GS} = 0\text{ V}, I_{SD} = 50\text{ A}, T_j = 25\text{ }^\circ\text{C}$		0.9	1.4	V
Continuous drain-source diode forward current ²	I_S	$T_c = 25\text{ }^\circ\text{C}$			100	A
Pulsed drain-source diode forward current	I_{SM}	—			400	A
Reverse recovery time	t_{rr}	$I_F=100\text{ A}, dI/dt=100\text{ A/us}$		66		ns
Reverse recovery charge	Q_{rr}				128	

Notes :

1. Guaranteed by design, not subject to production.
2. Surface Mounted on FR4 Board, $t \leq 10\text{ sec}$.
3. Pulse Test: Pulse Width $\leq 300\ \mu\text{s}$, Duty Cycle $\leq 2\%$.

Typical Characteristics

PD -- Tc

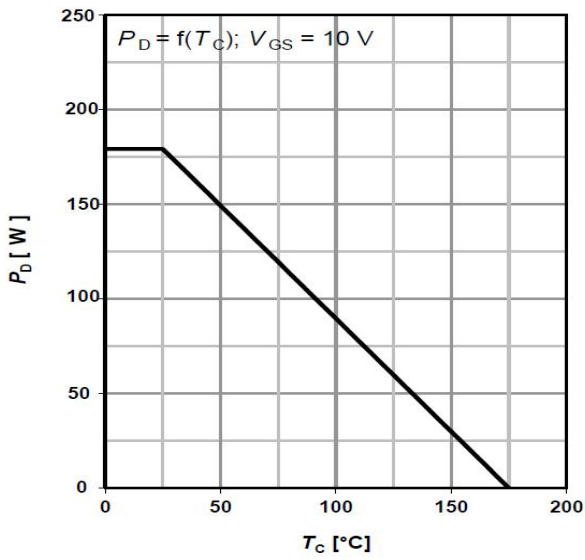

ID -- Tc

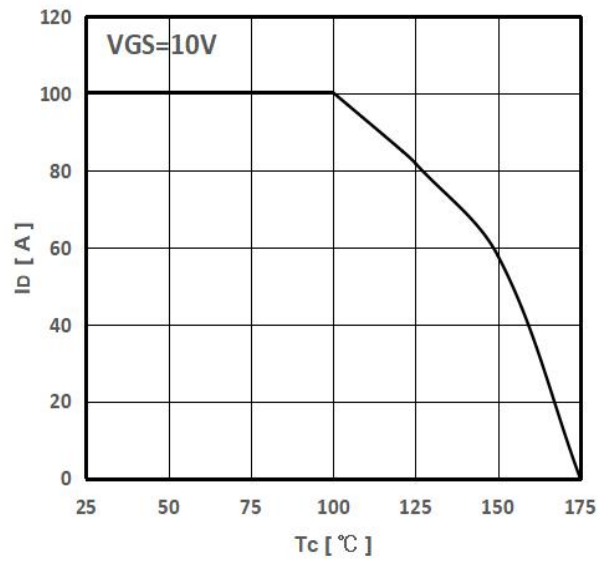

ID -- VDS

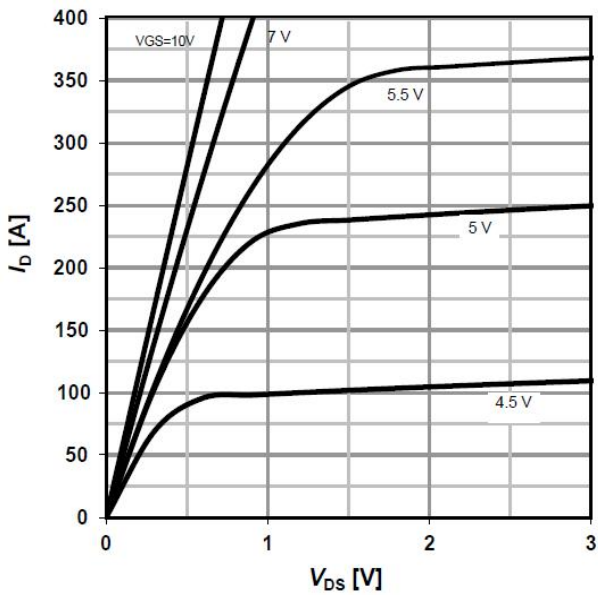

ID -- VGS

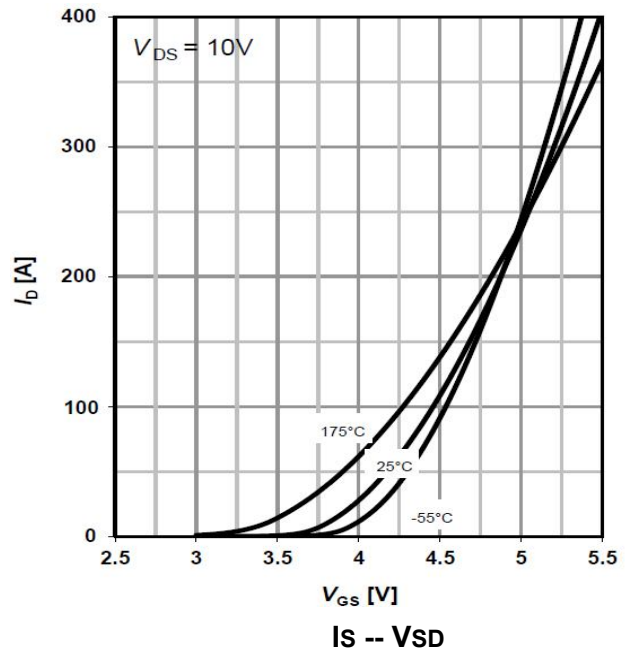

RDS(on) -- ID

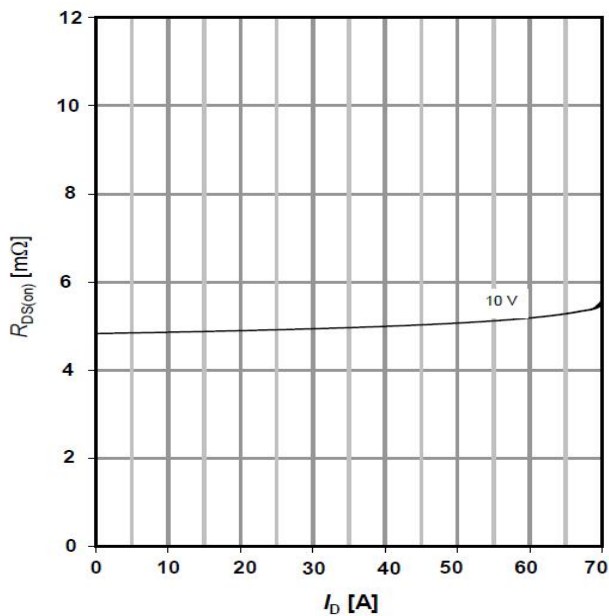

IS -- VSD

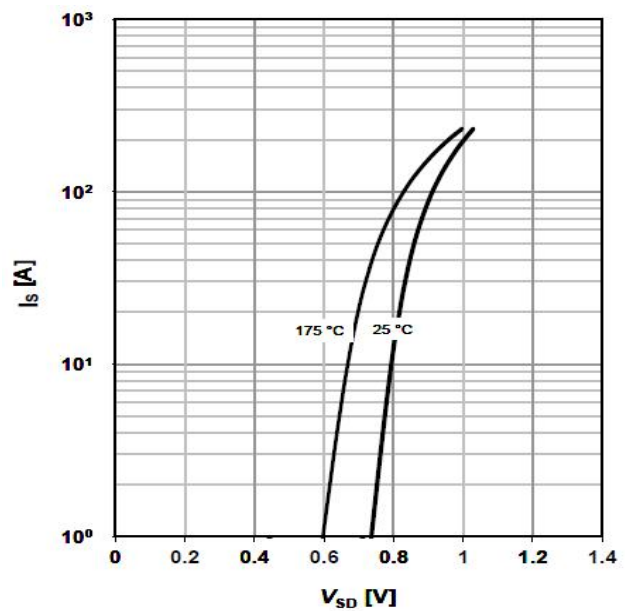

RDS(on) -- VGS

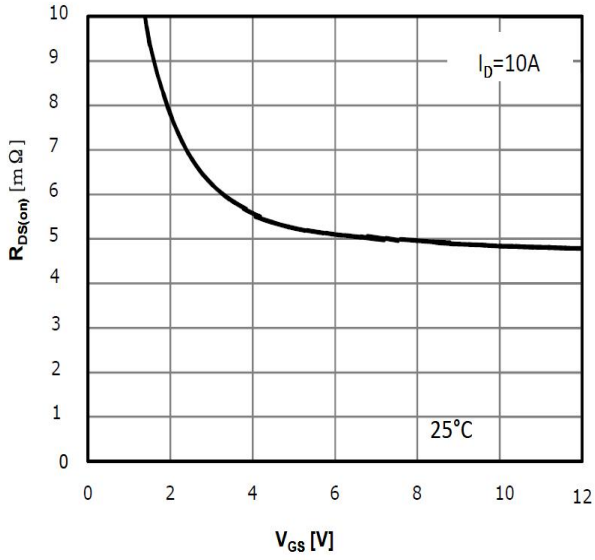

Threshold Voltage

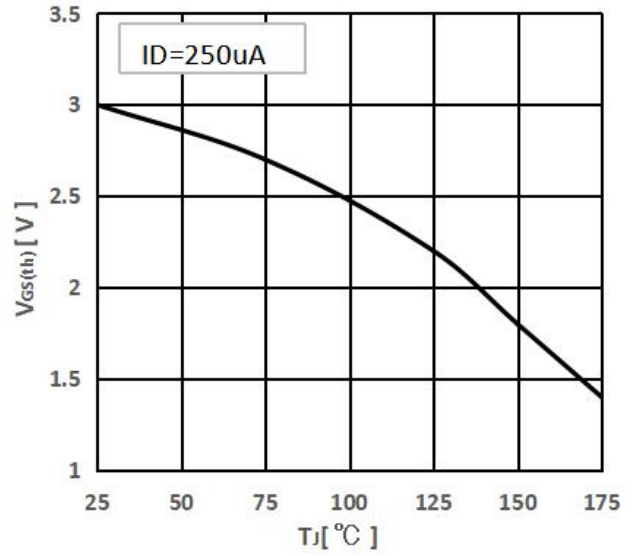

Drain-source breakdown voltage

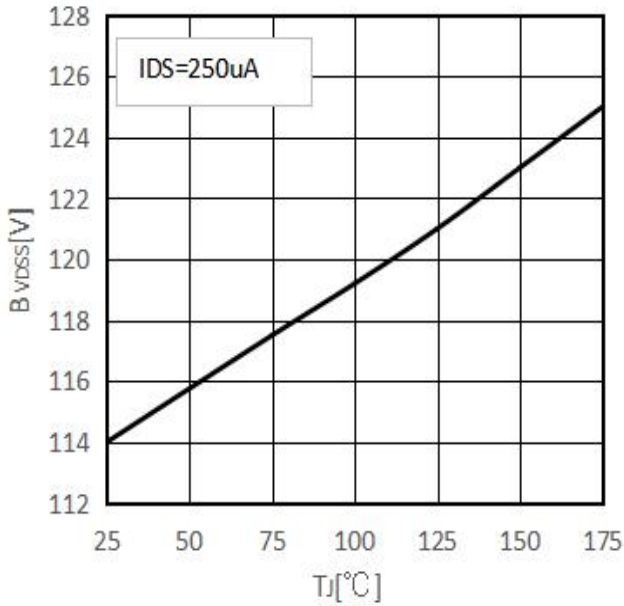

RDS (on) -- Tj

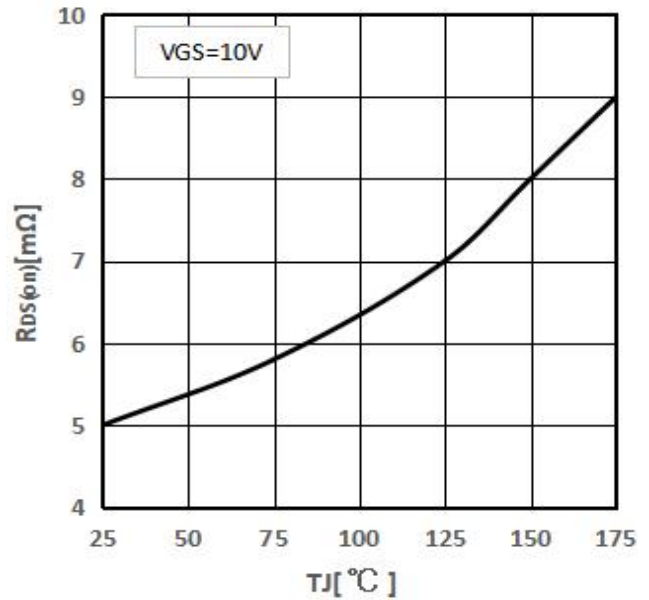

Typ.gate charge

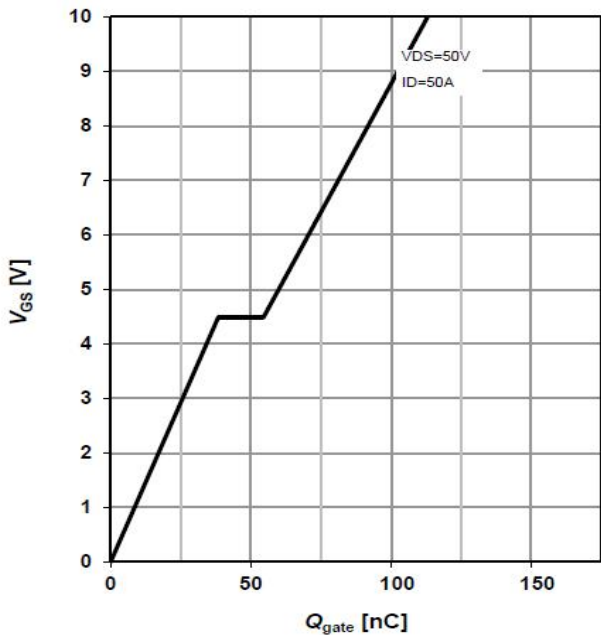

Avalanche energy

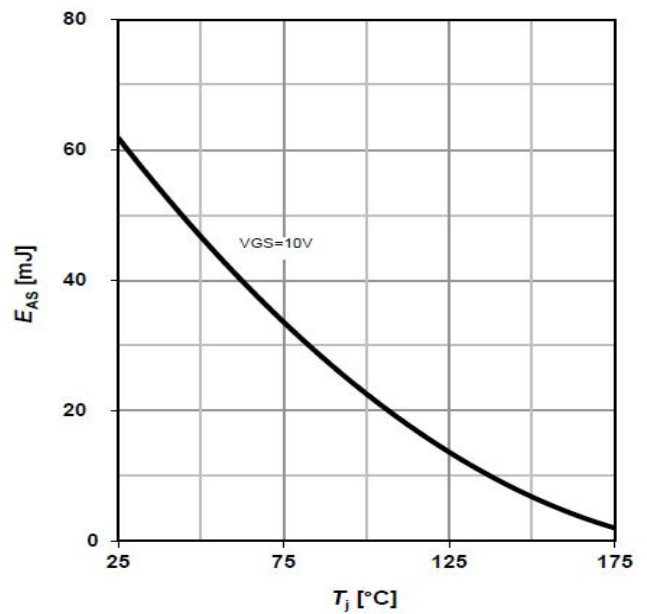

Typ. capacitance

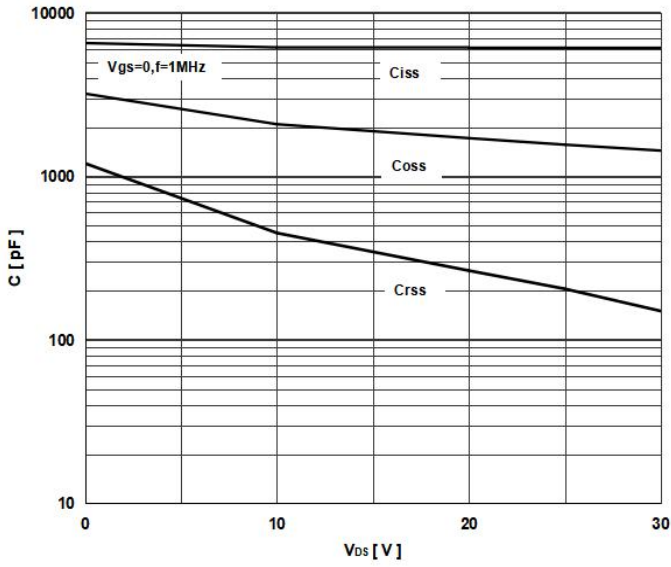

Gate charge waveforms

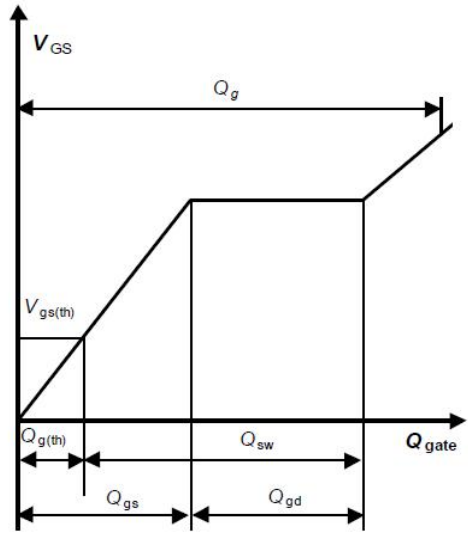

Maximum Forward Biased Safe Operating Area

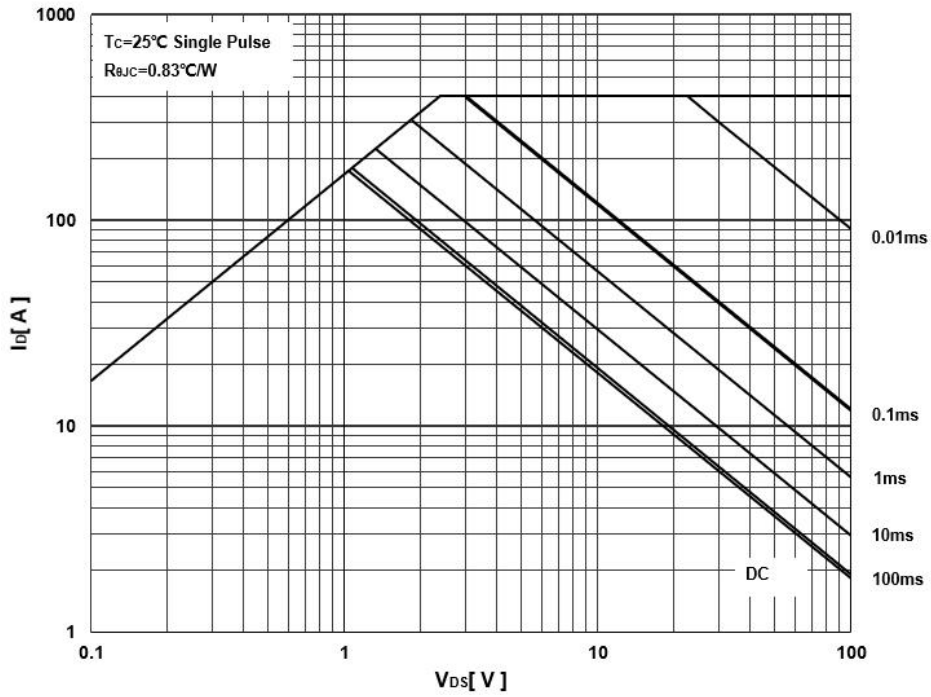

Normalized Thermal Transient Impedance

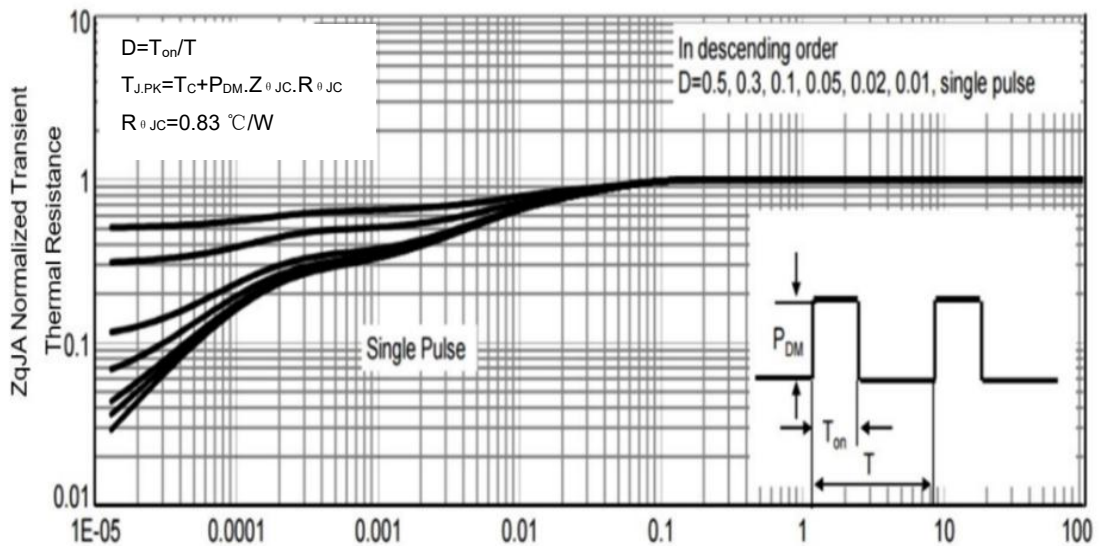

TO-252 Package Outline Dimensions

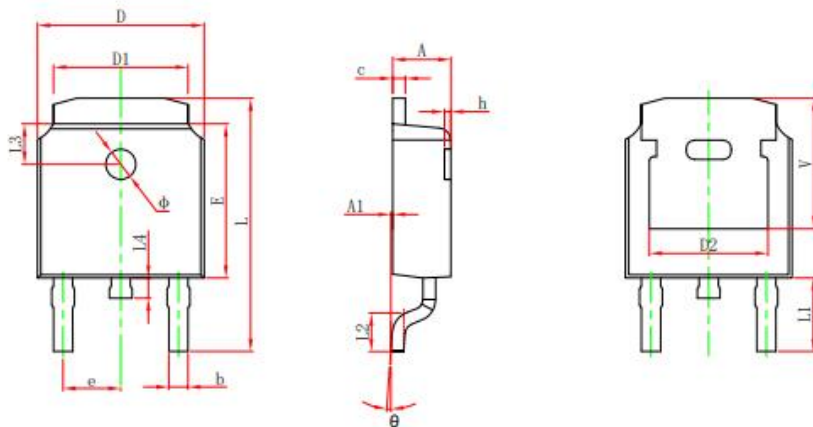

Symbol	Dimensions in Millimeters		Dimensions in Inches	
	Min.	Max.	Min.	Max.
A	2.200	2.400	0.087	0.094
A1	0.000	0.127	0.000	0.005
b	0.635	0.770	0.025	0.030
c	0.460	0.580	0.018	0.023
D	6.500	6.700	0.256	0.264
D1	5.100	5.460	0.201	0.215
D2	4.830 REF.		0.190 REF.	
E	6.000	6.200	0.236	0.244
e	2.186	2.386	0.086	0.094
L	9.712	10.312	0.382	0.406
L1	2.900 REF.		0.114 REF.	
L2	1.400	1.700	0.055	0.067
L3	1.600 REF.		0.063 REF.	
L4	0.600	1.000	0.024	0.039
Phi	1.100	1.300	0.043	0.051
theta	0°	8°	0°	8°
h	0.000	0.300	0.000	0.012
V	5.250 REF.		0.207 REF.	

TO-252-2L Suggested Pad Layout

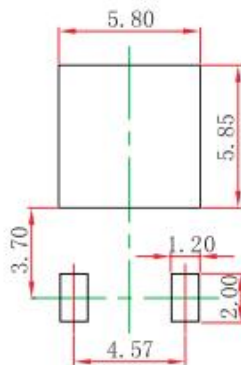

Note:

1. Controlling dimension: in millimeters.
2. General tolerance: 0.5mm.
3. The pad layout is for reference purposes only.

NOTICE

Cloudchild reserve the right to make modifications, enhancements, improvements, corrections or other changes without further notice to any product herein. Cloudchild does not assume any liability arising out of the application or use of any product described herein.

ChongQing Cloudchild Technology Co., Ltd. (short for Cloudchild) exerts the greatest possible effort to ensure high quality and reliability. Nevertheless, semiconductor devices in general can malfunction or fail due to their inherent electrical sensitivity and vulnerability to physical stress. It is the responsibility of the buyer, when utilizing Cloudchild products, to comply with the standards of safety in making a safe design for the entire system, including redundancy, fire-prevention measures, and malfunction prevention, to prevent any accidents, fires, or community damage that may ensue. In developing your designs, please ensure that Cloudchild products are used within specified operating ranges as set forth in the most recent Cloudchild products specifications.

TO-252-2L Tape and Reel

TO-252 Embossed Carrier Tape

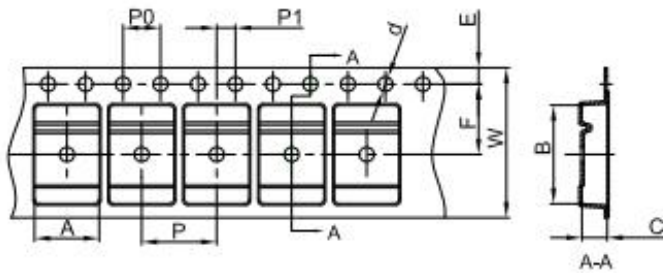

Packaging Description:

TO-252 parts are shipped in tape. The carrier tape is made from a dissipative (carbon filled) polycarbonate resin. The cover tape is a multilayer film (Heat Activated Adhesive in nature) primarily composed of polyester film, adhesive layer, sealant, and anti-static sprayed agent. These reeled parts in standard option are shipped with 25,00 units per 13" or 33.0 cm diameter reel. The reels are clear in color and is made of polystyrene plastic (anti-static coated).

Dimensions are in millimeter										
Pkg type	A	B	C	d	E	F	P0	P	P1	W
TO-252	6.90	10.50	2.70	Ø1.55	1.75	7.50	4.00	8.00	2.00	16.00

TO-252 Tape Leader and Trailer

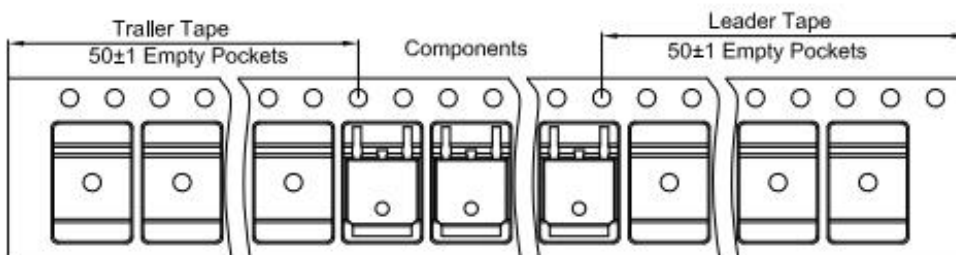

TO-252 Reel

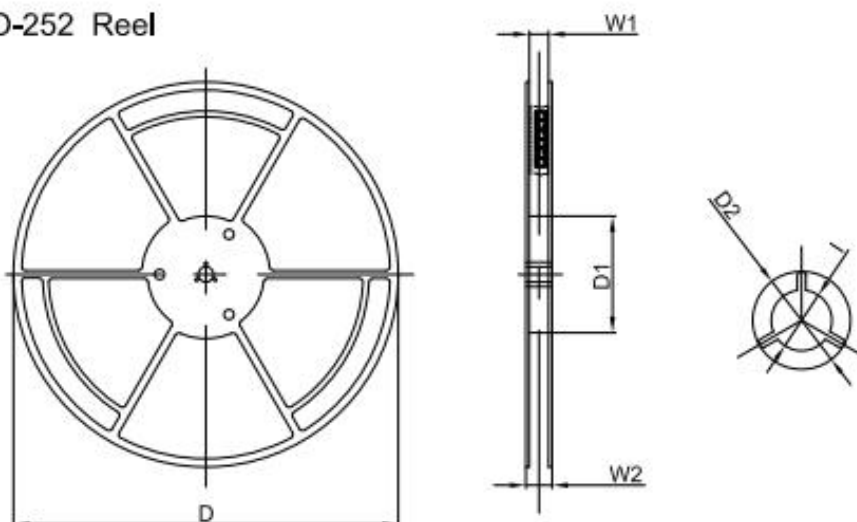

Dimensions are in millimeter						
Reel Option	D	D1	D2	W1	W2	I
13"Dia	330.00	100.00	Ø21.00	16.40	21.00	Ø13.00

REEL	Reel Size	Box	Box Size(mm)	Carton	Carton Size(mm)	G.W.(kg)
2,500 pcs	13Inch	2,500 pcs	340×336×29	25,000 pcs	353×346×365	

Date of change	Rev #	revise content
2023/06/05	A/0	/